

<p>Number</p> <p style="text-align: center;">CPS200-CB</p>	<p>Series</p> <p style="text-align: center;">CPS200</p> <p style="text-align: center;">Catch Basin 20" X 24" Box Only</p> <p style="text-align: center;">Pro Plus 100</p>
--	---

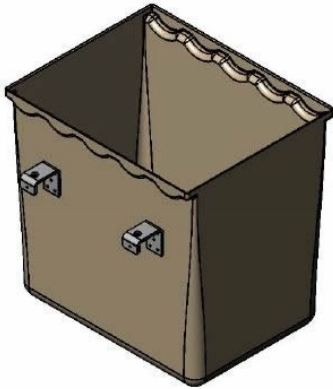

NOTE:
DUCTILE IRON FRAME AND CROSS SUPPORTS (NOT SHOWN) ARE REQ'D TO ACHIEVE LOAD CLASS C ON THIS CATCH BASIN. CATCH BASIN WITHOUT FRAME AND SUPPORTS WILL ONLY ACHIEVE CLASS A LOAD CLASS IF CLASS C GRATES ARE USED IN CATCH BASIN. REFER TO PPCB-GRATE DRAWING FOR MORE INFORMATION.

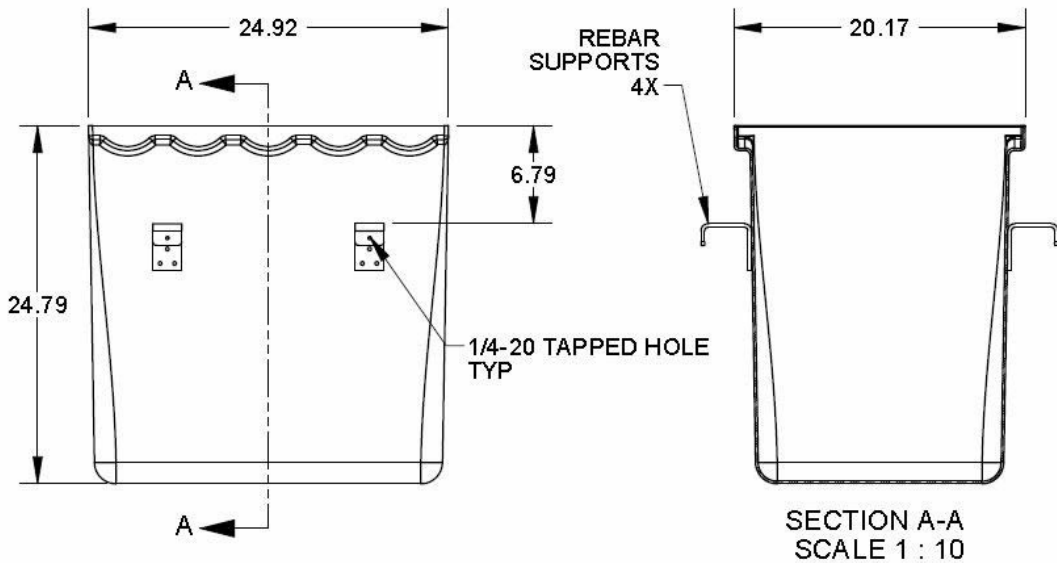
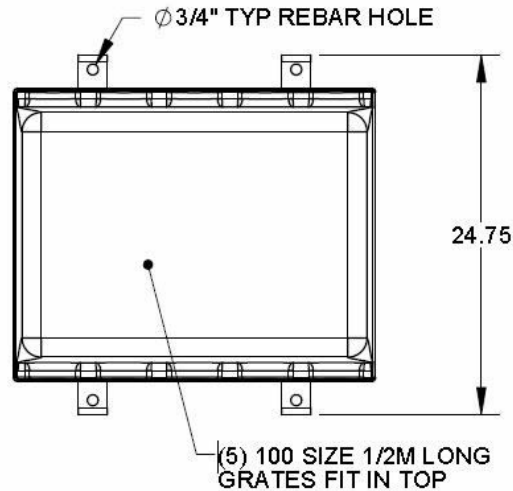

Manufacturer



Specification

JOSAM CATCH BASIN (BOX ONLY) FOR USE WITH PRO-PLUS 200C (8" INTERNAL WIDTH), SERIES.CHANNELS (GRATES EXTRA) BOX IS MADE OF GRP MATERIAL. CHANNEL CUTOUT PROFILE(S) TO BE DONE ON SITE. SUPPLIED BY TRENCH DRAIN SUPPLY

DISCLAIMER - The customer and the customer's architects, engineers, consultants, and other professionals are completely responsible for the selection installation and maintenance of any product purchased from Trench Drain Supply and/or its manufacturers. TRENCH DRAIN SUPPLY MAKES NO WARRANTY, EXPRESS OR IMPLIED, AS TO THE SUITABILITY, DESIGN, MERCHANTABILITY, OR FITNESS OF THE PRODUCT FOR CUSTOMERS APPLICATION. The drawing and information provided remain the property and copyright of the manufacturer listed. The manufacturer reserves the right to modify specification without notice.